

General Description

The MIC49200 is a high-bandwidth, low-dropout, 2A voltage regulator ideal for powering core voltages of low-power microprocessors. The MIC49200 implements a dual supply configuration allowing for very low output impedance and very fast transient response.

The MIC49200 requires a bias input supply and a main input supply, allowing for ultra-low input voltages on the main supply rail. The input supply operates from 1.4V to 6.5V and the bias supply requires between 3V and 6.5V for proper operation. The MIC49200 offers fixed output voltages from 0.9V to 1.8V and adjustable output voltages down to 0.9V.

The MIC49200 requires a minimum of output capacitance for stability, working optimally with small ceramic capacitors.

The MIC49200 is available in a 5-pin S-Pak. Its operating temperature range is -40°C to $+125^{\circ}\text{C}$.

Data sheets and support documentation can be found on Micrel's web site at: www.micrel.com.

Features

- Input Voltage Range:
 V_{IN} : 1.4V to 6.5V
 V_{BIAS} : 3.0V to 6.5V
- **Stable with 1 μF ceramic output capacitors**
- $\pm 1\%$ initial tolerance
- Maximum dropout voltage ($V_{IN}-V_{OUT}$) of 500mV over temperature
- **Adjustable output voltage down to 0.9V**
- Ultra fast transient response (Up to 10MHz bandwidth)
- Excellent line and load regulation specifications
- Logic controlled shutdown option
- Thermal shutdown and current limit protection
- Junction temperature range: -40°C to 125°C

Applications

- Set-top box
- Graphics processors
- PC add-in cards
- Microprocessor core voltage supply
- Low voltage digital ICs
- High efficiency linear power supplies
- SMPS post regulators

Typical Application

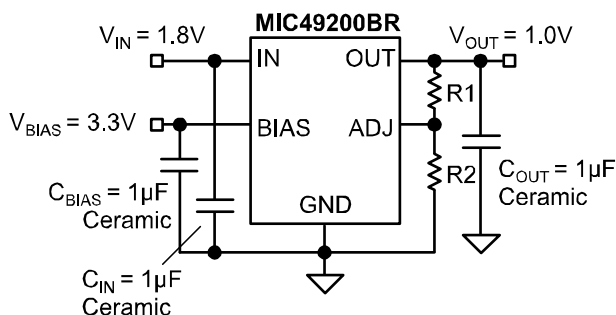

Low Voltage, Fast Transient Response Regulator

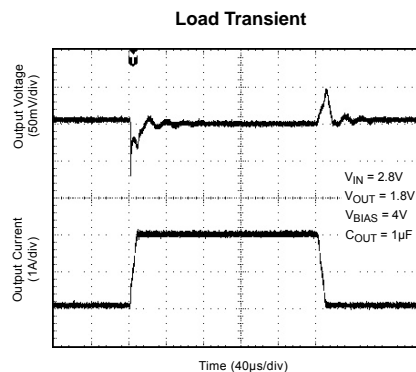

Ordering Information

Part Number RoHS Compliant	Output Current	Voltage	Junction Temperature Range	Package
MIC49200-1.0WR*	2A	1.0V	-40°C to +125°C	S-Pak-5
MIC49200-1.8WR*	2A	1.8V	-40°C to +125°C	S-Pak-5
MIC49200WR*	2A	Adj	-40°C to +125°C	S-Pak-5

* RoHS compliant with 'high-melting solder' exemption.

Pin Configuration

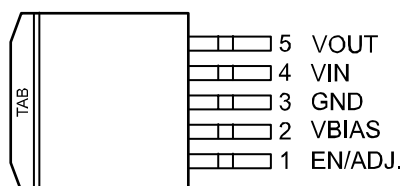

5-Pin S-Pak (R)

Pin Description

Pin Number S-Pak-5	Pin Name	Pin Function
1	EN	Enable (Input): CMOS compatible input. Logic High = enable; Logic Low = shutdown.
	ADJ	Adjustable regulator feedback input. Connect to resistor voltage divider.
2	VBIAS	Input Bias voltage for powering all circuitry on the regulator with the exception of the output power device.
3	GND	Ground (TAB is connected to ground on S-Pak).
4	VIN	Input voltage which supplies current to the output power device.
5	VOUT	Regulator Output.

Absolute Maximum Ratings⁽¹⁾

Supply Voltage (V_{IN}).....	8V
Bias Supply Voltage (V_{BIAS}).....	8V
Enable Input Voltage (V_{EN}).....	8V
Power Dissipation.....	Internally Limited
ESD Rating ⁽³⁾	3kV

Operating Ratings⁽²⁾

Supply voltage (V_{IN}).....	1.4V to 6.5V
Bias Supply Voltage (V_{BIAS}).....	3V to 6.5V
Enable Input Voltage (V_{EN}).....	0V to 6.5V
Junction Temperature	$-40^{\circ}\text{C} \leq T_J \leq +125^{\circ}\text{C}$
Package Thermal Resistance	
S-Pak (θ_{JA})	$2^{\circ}\text{C}/\text{W}$

Electrical Characteristics⁽⁴⁾

$T_A = 25^{\circ}\text{C}$ with $V_{BIAS} = V_{OUT} + 2.2\text{V}$; $V_{IN} = V_{OUT} + 1\text{V}$; **bold** values indicate $-40^{\circ}\text{C} \leq T_J \leq +125^{\circ}\text{C}$ ⁽⁵⁾, unless noted.

Parameter	Conditions	Min	Typ	Max	Units
Output Voltage Accuracy	At 25°C	-1		+1	%
	Over temperature range ($I_{OUT} = 10\text{mA}$)	-2		+2	%
Line Regulation	$V_{IN} = V_{OUT} + 1\text{V}$ to 6.5V	-0.1	0.01	+0.1	%/V
Load Regulation	$I_L = 10\text{mA}$ to 2A		0.2	1	%
				1.5	%
Dropout Voltage ($V_{IN} - V_{OUT}$) (Note 5)	$I_L = 750\text{mA}$		130	200	mV
	$I_L = 1.5\text{A}$		280	300	mV
				400	mV
	$I_L = 2\text{A}$		400	500	mV
Dropout Voltage ($V_{BIAS} - V_{OUT}$) (Note 5)	$I_L = 750\text{mA}$		1.3		V
	$I_L = 1.5\text{A}$		1.65	1.9	V
				2.1	V
	$I_L = 2\text{A}$		1.75	2.0	V
Ground Current (Note 6)	$I_L = 0\text{mA}$		15		mA
	$I_L = 2\text{A}$		15	25	mA
				30	mA
Ground Pin Current in Shutdown	$V_{EN} \leq 0.6\text{V}$, ($V_{BIAS} + I_{INPUT}$) (Note 7)		0.5	1	μA
				2	μA
Current thru V_{BIAS}	$I_L = 0\text{mA}$		9	15	mA
	$I_L = 2\text{A}$		40	25	mA
Current Limit	$V_{OUT} = 0\text{V}$	2.5	3.5	5.3	A
				6	A
Enable Input Threshold	Regulator enable	1.6			V
	Regulator shutdown			0.6	V
Enable Pin Input Current	Independent of state		0.1	1	μA
Reference					
Reference Voltage	Adjustable version	0.891	0.9	0.909	V
		0.882		0.918	V

Notes:

1. Exceeding the absolute maximum rating may damage the device.
2. The device is not guaranteed to function outside its operating range.
3. Devices are ESD sensitive. Handling precautions recommended. Human body model, 1.5k in series with 100pF.
4. Specification for packaged product only.
5. For $V_{OUT} \leq 1.1V$, V_{BIAS} dropout specification does not apply due to a minimum 3V V_{BIAS} input. Dropout voltage is defined as the input-to-output differential at which the output voltage drops 2% below its nominal value measured at 1V differential for V_{IN} and 2.2V differential for V_{BIAS} . For outputs below 1.4V, dropout voltage is the input-to-output voltage differential with the minimum input voltage 1.4V.
6. $I_{GND} = I_{BIAS} + (I_{IN} - I_{OUT})$. At high loads, input current on V_{IN} will be less than the output current, due to drive current being supplied by V_{BIAS} .
7. Fixed output voltage versions only.

Functional Diagram

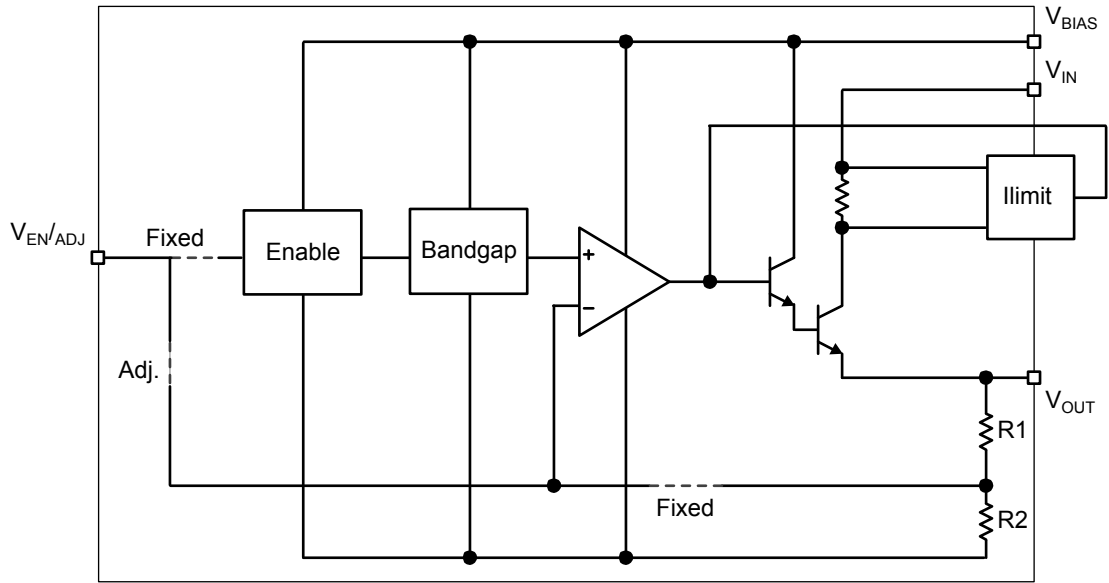

Typical Characteristics

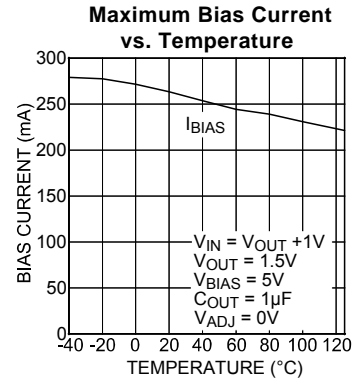
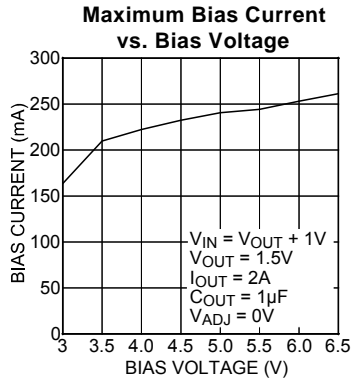
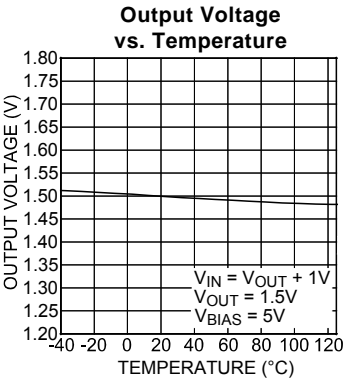
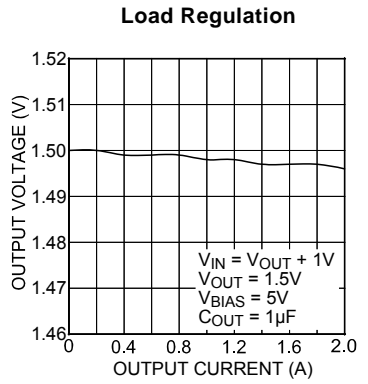
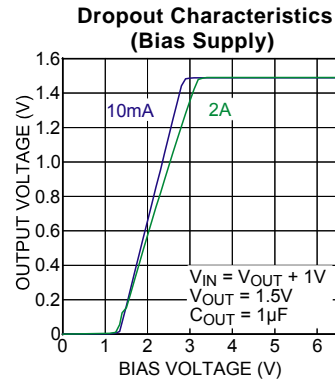
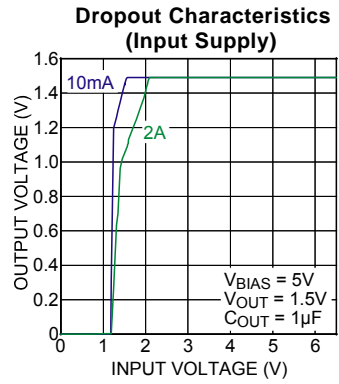
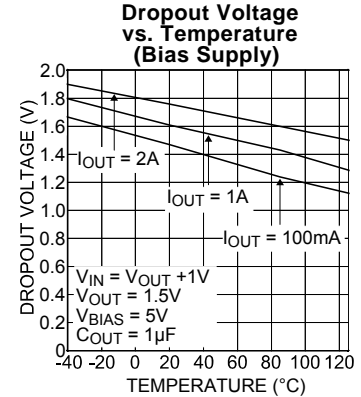
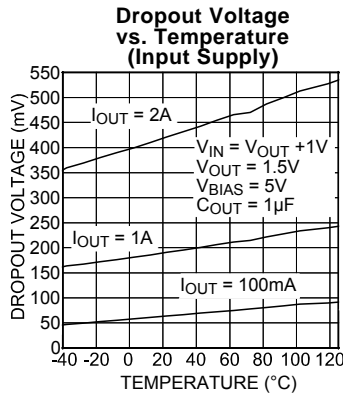
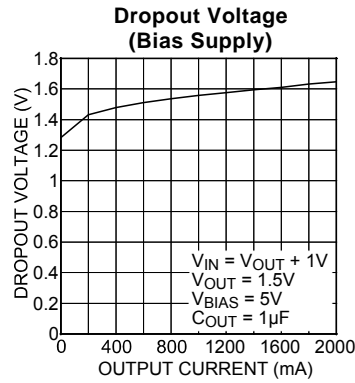
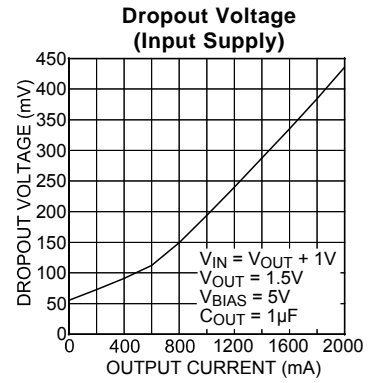
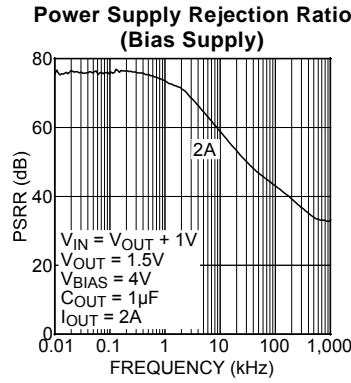
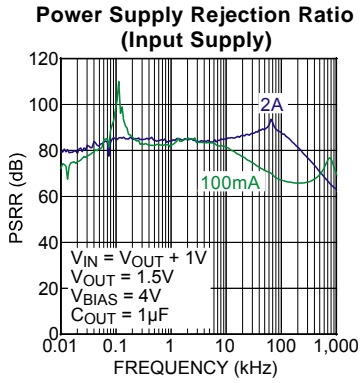

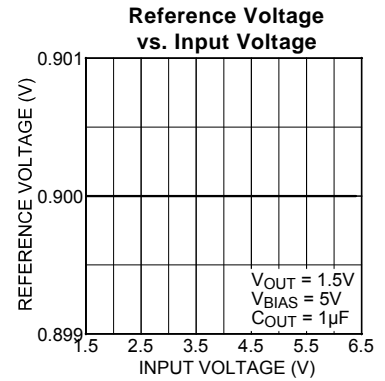
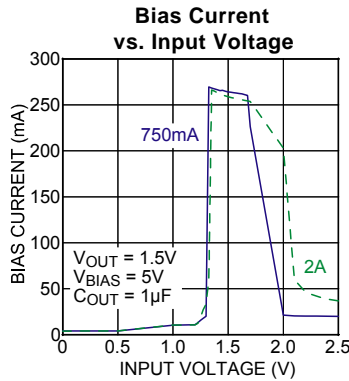
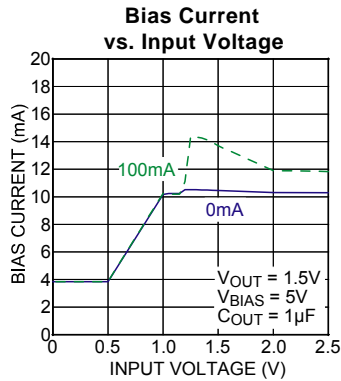
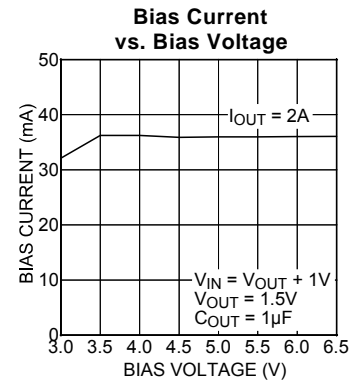
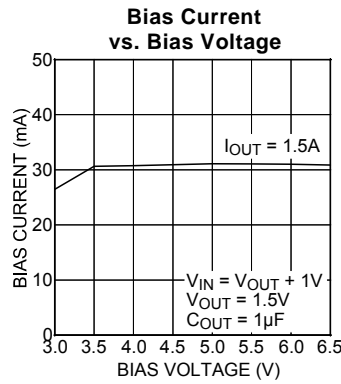
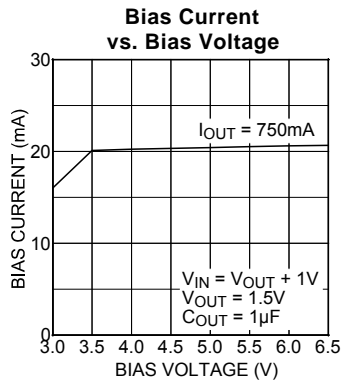
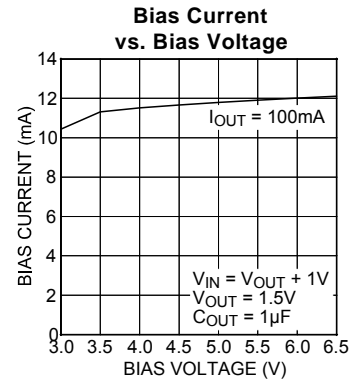
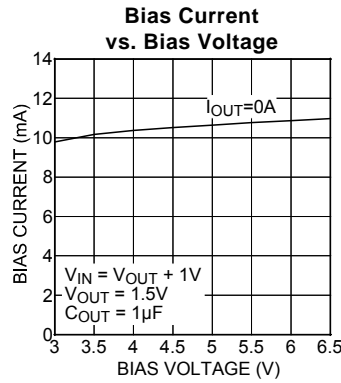
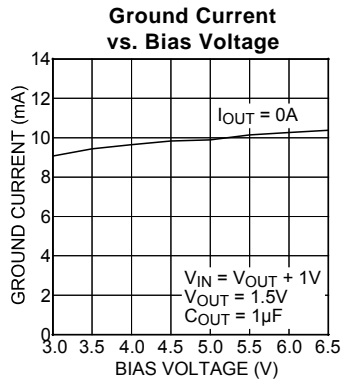
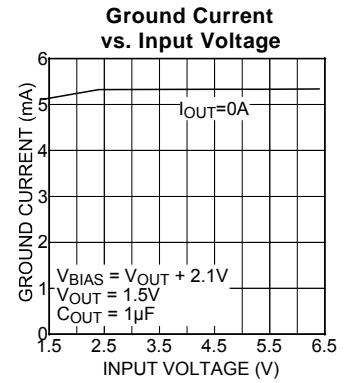
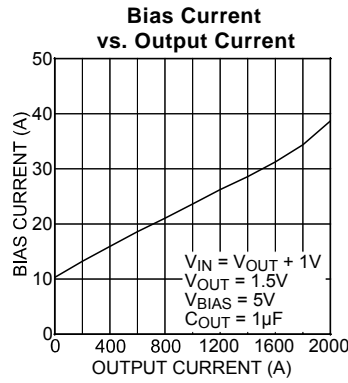
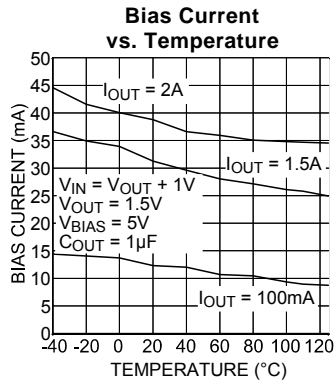

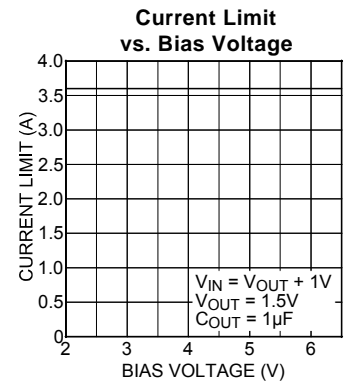
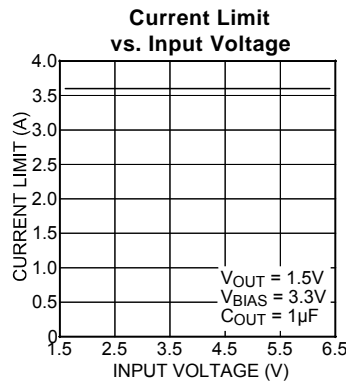
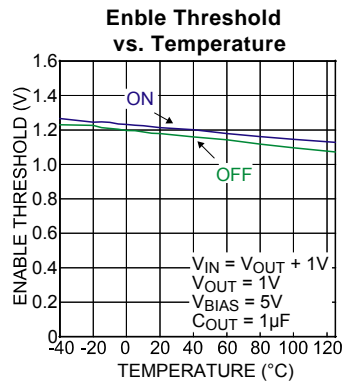
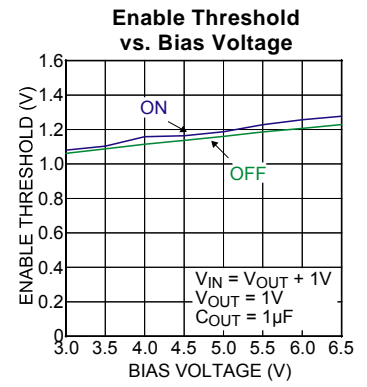
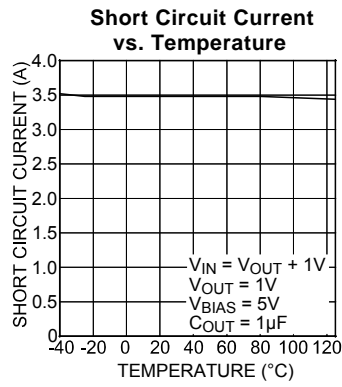
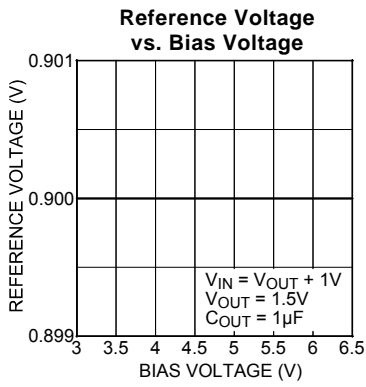

Functional Characteristics

Line Transient (V_{IN})

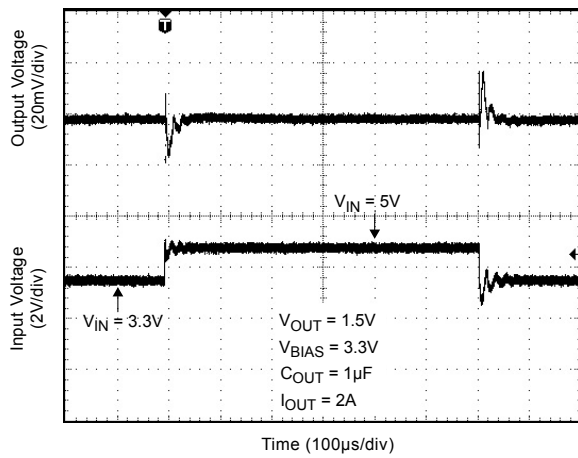

Line Transient (V_{BIAS})

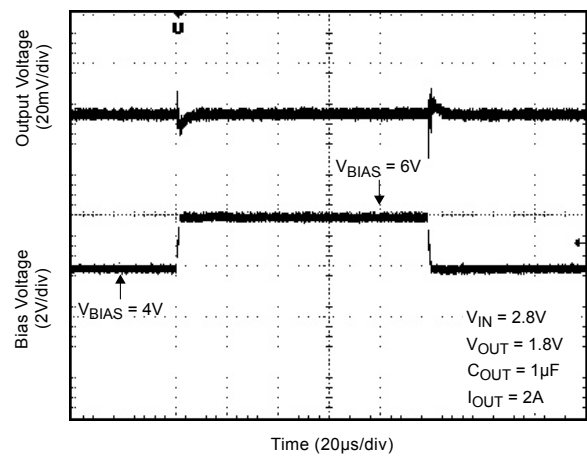

Enable Turn-On

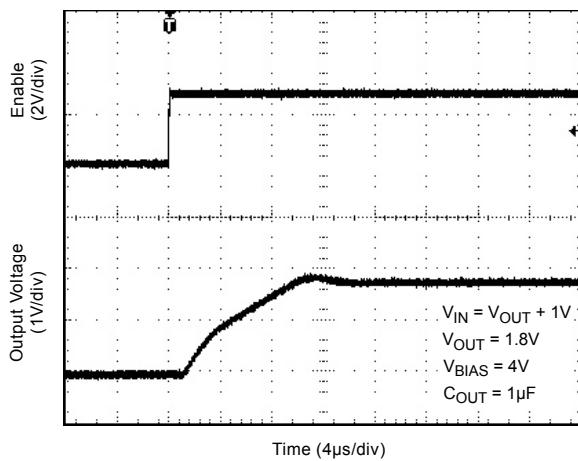

Load Transient

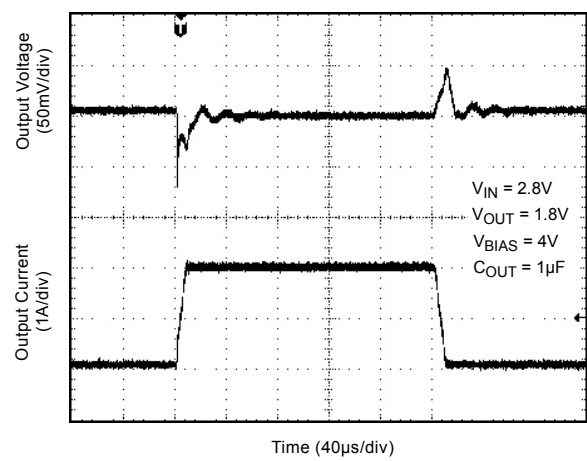

Applications Information

The MIC49200 is an ultra-high performance, low-dropout linear regulator designed for high current applications requiring fast transient response. The MIC49200 utilizes two input supplies, significantly reducing dropout voltage, perfect for low-voltage, DC-to-DC conversion. The MIC49200 requires a minimum of external components and obtains a bandwidth of up to 10MHz. As a μ Cap regulator, the output is tolerant of virtually any type of capacitor including ceramic type and tantalum type capacitors.

The MIC49200 regulator is fully protected from damage due to fault conditions, offering linear current limiting and thermal shutdown.

Bias Supply Voltage

V_{BIAS} , requiring relatively light current, provides power to the control portion of the MIC49200. V_{BIAS} requires approximately 40mA for a 1.5A load current. Dropout conditions require higher currents. Most of the biasing current is used to supply the base current to the pass transistor. This allows the pass element to be driven into saturation thereby reducing the dropout to 400mV at a 2A load current. Bypassing on the bias pin is recommended to improve performance of the regulator during line and load transients. Small ceramic capacitors from V_{BIAS} -to-ground help reduce high-frequency noise from being injected into the control circuitry from the bias rail and represent good design practice. Good bypass techniques typically include one larger capacitor such as 1 μ F ceramic and smaller valued capacitors such as 0.01 μ F or 0.001 μ F in parallel with that larger capacitor to decouple the bias supply. The V_{BIAS} input voltage must be 2.1V above the output voltage with a minimum V_{BIAS} input voltage of 3 volts.

Input Supply Voltage

V_{IN} provides the high current to the collector of the pass transistor. The minimum input voltage is 1.4V, allowing conversion from low voltage supplies.

Output Capacitor

The MIC49200 requires a minimum of output capacitance to maintain stability. However, proper capacitor selection is important to ensure desired transient response. The MIC49200 is specifically designed to be stable with virtually any capacitance value and ESR. A 1 μ F ceramic chip capacitor should satisfy most applications. Output capacitance can be increased without bound. See "Typical Characteristic" subsection for examples of load transient response.

X7R dielectric ceramic capacitors are recommended because of their temperature performance. X7R-type capacitors change capacitance by 15% over their operating temperature range and are the most stable type of ceramic capacitors. Z5U and Y5V dielectric capacitors change value by as much as 50% and 60% respectively over their operating temperature ranges. To use a ceramic chip capacitor with Y5V dielectric, the value must be much higher than an X7R ceramic or a tantalum capacitor to ensure the same capacitance value over the operating temperature range. Tantalum capacitors have a very stable dielectric (10% over their operating temperature range) and can also be used with this device.

Input Capacitor

An input capacitor of 1 μ F or greater is recommended when the device is more than 4" away from the bulk supply capacitance, or when the supply is a battery. Small, surface-mount, ceramic chip capacitors can be used for the bypassing. The capacitor should be placed within 1" of the device for optimal performance. Larger values will help to improve ripple rejection by bypassing the input to the regulator, further improving the integrity of the output voltage.

Thermal Design

Linear regulators are simple to use. The most complicated design parameters to consider are thermal characteristics. Thermal design requires the following application-specific parameters:

- Maximum ambient temperature (T_A)
- Output current (I_{OUT})
- Output voltage (V_{OUT})
- Input voltage (V_{IN})
- Ground current (I_{GND})

First, calculate the power dissipation of the regulator from these numbers and the device parameters from this datasheet.

$$P_D = V_{IN} \times I_{IN} + V_{BIAS} \times I_{BIAS} - V_{OUT} \times I_{OUT}$$

As the load increases, the input current will be less than the output current at high output currents. The bias current is a sum of base drive and ground current. Ground current is constant over load current. The heat sink thermal resistance is determined with this formula:

$$\theta_{SA} = \frac{T_{J(MAX)} - T_A}{P_D}$$

The heat sink may be significantly reduced in applications where the maximum input voltage is known and large compared with the dropout voltage. Use a series input resistor to drop excessive voltage and distribute the heat between this resistor and the regulator. The low-dropout properties of the MIC49200 allow significant reductions in regulator power dissipation and the associated heat sink without compromising performance. When this technique is employed, a capacitor of at least 1 μ F is needed directly between the input and regulator ground. Refer to "[Application Note 9](#)" for further details and examples on thermal design and heat sink specification.

Minimum Load Current

The MIC49200, unlike most other high current regulators, does not require a minimum load to maintain output voltage regulation.

Adjustable Regulator Design

The MIC49200 adjustable version allows programming the output voltage anywhere between 0.9V and 5V. Two resistors are used. The resistor value between V_{OUT} and the adjust pin should not exceed 10k Ω . Larger values can cause instability. The resistor values are calculated by:

$$V_{OUT} = 0.9 \left(\frac{R_1}{R_2} + 1 \right)$$

Where V_{OUT} is the desired output voltage.

Enable

The fixed output voltage versions of the MIC49200 feature an active high enable input (EN) that allows on-off control of the regulator. Supply currents reduce to "zero" when the device is in shutdown, with only microamperes of leakage current. The EN input has TTL/CMOS compatible thresholds for simple logic interfacing. EN may be directly tied to V_{IN} and pulled up to the maximum supply voltage.

Package Information

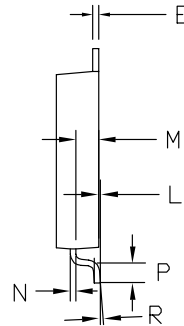
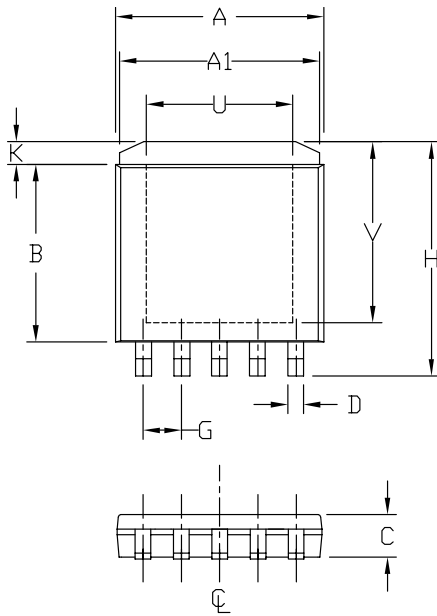

	INCHES		MILLIMETERS	
A	0.365	0.375	9.27	9.52
A1	0.350	0.360	8.89	9.14
B	0.310	0.320	7.87	8.13
C	0.070	0.080	1.78	2.03
D	0.025	0.031	0.63	0.79
E	0.010	BSC	0.25	BSC
G	0.067	BSC	1.70	BSC
H	0.410	0.420	10.41	10.67
K	0.030	0.050	0.76	1.27
L	0.001	0.005	0.03	0.13
M	0.035	0.045	0.89	1.14
N	0.010	BSC	0.25	BSC
P	0.031	0.041	0.79	1.04
R	0*	6*	0*	6*
U	0.256	BSC	6.50	BSC
V	0.316	BSC	8.03	BSC

1. DIMENSION DOES NOT INCLUDE MOLD FLASH OR PROTRUSIONS.
2. DIMENSION INCLUDES PLATING THICKNESS

5-Pin S-Pak (R)

MICREL, INC. 2180 FORTUNE DRIVE SAN JOSE, CA 95131 USA
 TEL +1 (408) 944-0800 FAX +1 (408) 474-1000 WEB <http://www.micrel.com>

The information furnished by Micrel in this data sheet is believed to be accurate and reliable. However, no responsibility is assumed by Micrel for its use. Micrel reserves the right to change circuitry and specifications at any time without notification to the customer.

Micrel Products are not designed or authorized for use as components in life support appliances, devices or systems where malfunction of a product can reasonably be expected to result in personal injury. Life support devices or systems are devices or systems that (a) are intended for surgical implant into the body or (b) support or sustain life, and whose failure to perform can be reasonably expected to result in a significant injury to the user. A Purchaser's use or sale of Micrel Products for use in life support appliances, devices or systems is a Purchaser's own risk and Purchaser agrees to fully indemnify Micrel for any damages resulting from such use or sale.

© 2005 Micrel, Inc.